

S.O.B.

SPECIAL OPERATIONS BUNKER

The S.O.B. (Special Operation Bunker) can best be described as a portable rolling rifle grade ballistic shield. Each S.O.B. is a freestanding shield that offers considerable protection while not burdening the operator since it is not carried to position.

They can be utilized for a variety of applications that include barricaded suspects, critical tactical negotiations, hostage rescue operations, first responders to active shooters, officer and citizen rescues, sniper deployment and E.O.D. response teams. The capabilities of these S.O.B.s are endless.

In the Little S.O.B. and the Little Double S.O.B. the individual shields that comprise the rifle grade (N.I.J. III+) ballistics can be removed from the frame and used individually as N.I.J. IIIA shields. The panels may be utilized as separate ballistic shields or combined to form a long ballistic wall.



The Little S.O.B.

75" H. 22" W. rolling rifle or handgun rated shield



The Little Double S.O.B.

70" H. x 44" W. rolling rifle or handgun rated shield

- Rifle or handgun rated protection. panel options are:
 - N.I.J. Level IIIA (.44 magnum) Panels
 - N.I.J. Level III (7.62mm Ball, M80, 149 gr.) Panels
 - N.I.J. Level IV (.30 AP, M2) Panels
- N.I.J. Level IV Vision Glass
- Is not carried to position
- One hand maneuverability
- Hands free, once in position
- Portable, easy to transport
- Run flat tires
- Fits through 3' door
- Rolls over rough terrain
- Gun port (optional)



The Collapsible S.O.B.

75" H. x 22" W. rolling rifle or handgun rated shield
Can be collapsed to 15.5" H. x 29.5" W. x 33.5" D.
and stored vertically or horizontally



DAW TECH

For additional information please contact Bob Bradshaw @ 801.977.3132 or visit www.ballisticbunker.com

REV	DESCRIPTION	DATE	BY
A	INITIAL RELEASE		

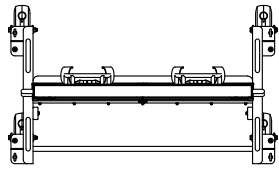

TOP VIEW

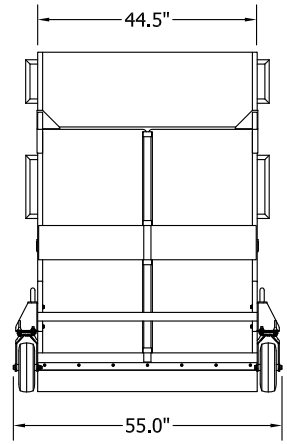

FRONT VIEW

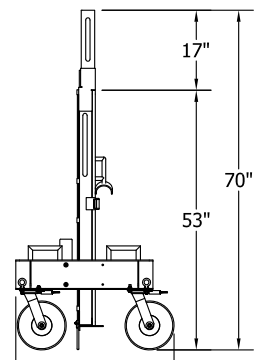

SIDE VIEW

(30" W/ WHEELS ROTATED 90°)

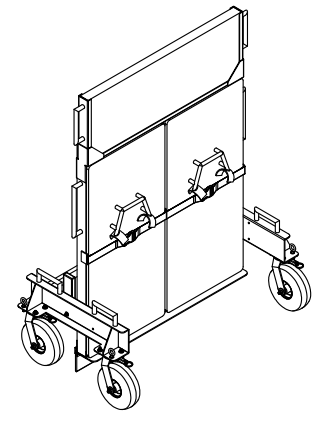

ISOMETRIC

LITTLE DOUBLE S.O.B.

ITEM	DAW NO	DESCRIPTION	QTY
<p>UNLESS OTHERWISE SPECIFIED DIMENSIONS ARE IN INCHES</p> <p>UNSPECIFIED TOLERANCES</p> <p>DECIMALS: in mm</p> <p>X = .1 = 2.5</p> <p>XX = .05 = 1.25</p> <p>XXX = .031 = 0.787</p> <p>ANGULAR: = .5°</p>			
<p>DAW TECH 1600 West 2200 South #210, Salt Lake City, Utah 84119-2418 (801) 977-3100 www.dawtech.com</p> <p>BALLISTIC BUNKERS LITTLE DOUBLE S.O.B.</p>			
DRWING NO	DATE	SCALE	REV
PS		1/16"	
CHECKED BY	DATE	SIZE	REV
		B	
SB03 -A1			A

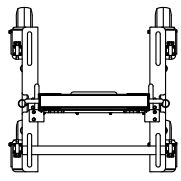

TOP VIEW

NOTE:
The width and height dimensions are identical for both the Little S.O.B. and the Collapsible S.O.B.

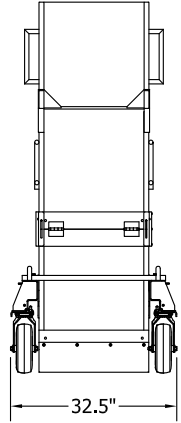

FRONT VIEW

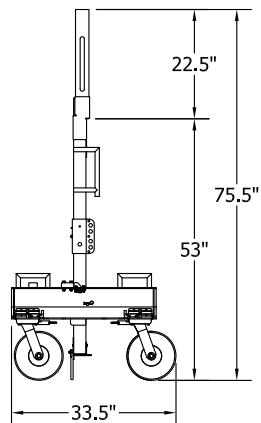

SIDE VIEW

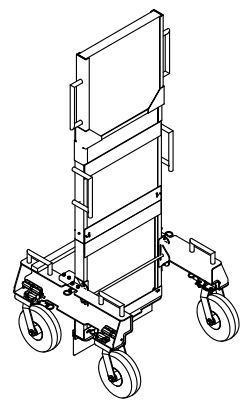

ISOMETRIC

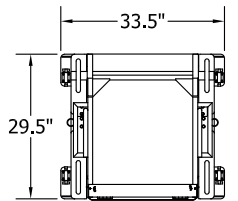

TOP VIEW

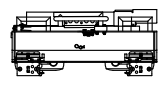

SIDE VIEW

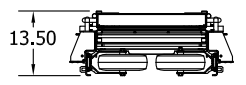

SIDE VIEW

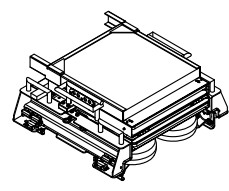

ISOMETRIC (STOWED HORIZ.)

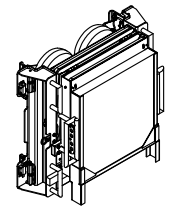

ISOMETRIC (STOWED VERT.)

COLLAPSED

COLLAPSIBLE S.O.B.

ITEM	DAW NO	DESCRIPTION	QTY
<p>UNLESS OTHERWISE SPECIFIED DIMENSIONS ARE IN INCHES</p> <p>UNSPECIFIED TOLERANCES</p> <p>DECIMALS: in mm</p> <p>X = .1 = 2.5</p> <p>XX = .05 = 1.25</p> <p>XXX = .031 = 0.787</p> <p>ANGULAR: = .5°</p>			
<p>DAW TECH 1600 West 2200 South #210, Salt Lake City, Utah 84119-2418 (801) 977-3100 www.dawtech.com</p> <p>BALLISTIC BUNKERS COLLAPSIBLE S.O.B.</p>			
DRWING NO	DATE	SCALE	REV
PS		1/16"	
CHECKED BY	DATE	SIZE	REV
		B	
SB04 -A1			A